

SOU<sup>L</sup>wood<sup>®</sup>

SOU<sup>L</sup>wood<sup>®</sup>

PS WALL CHARCOAL LOUVERS

PRODUCT AND DESIGN CATALOGUE 2024

**ITEM NO. MOULD**

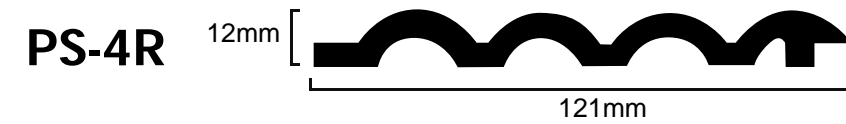

**ITEM NO. MOULD**



**ITEM NO. MOULD**

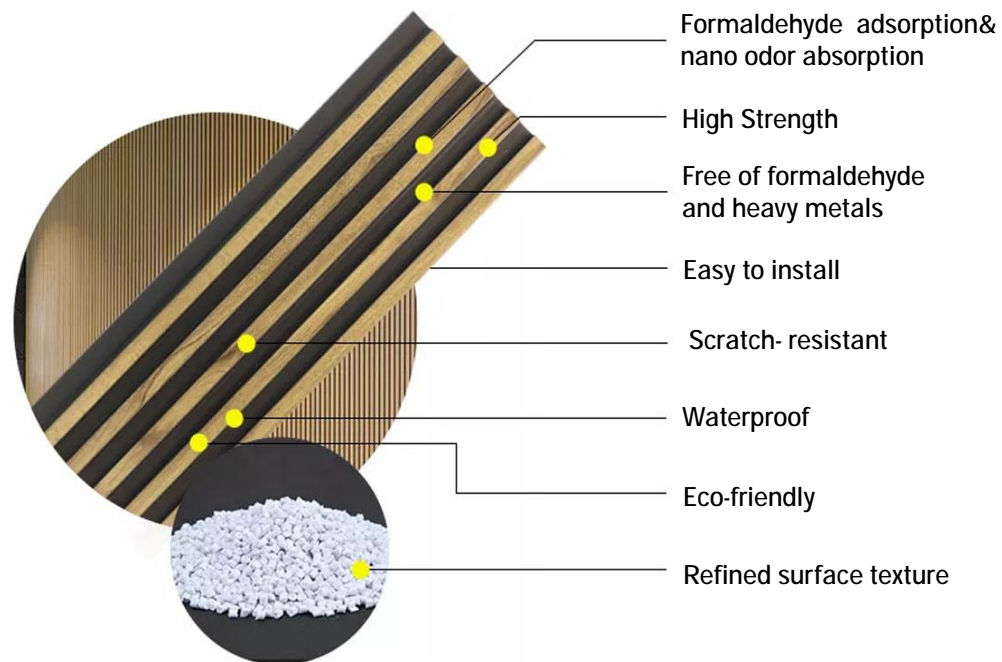
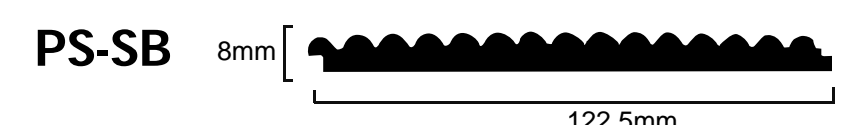
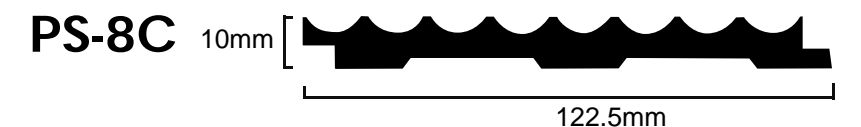

PS high density extruded polystyrene wall panel with smooth surface and ribbed back for better glue adhesion.

Highly resistant and suitable for indoor areas-made with high density polymes. Pieces with a smooth,pre-painted front, perfect edges and a textured back for better glue adhesion.

**Features:**

High density expanded polystyrene core, produced with virgin raw material.

Moisture and pre-painted front with perfect edges.

Smooth and pre-painted front with perfect edges.

Ribbed back for better glue adhesion.



SOULwood®



SOULwood®



PS WALL PANEL CHARCOAL LOUVERS



NAME	SIZE	CODE	AREA
PS WALL PANEL	2900*121*12mm	PS-3L	20 PCS/CTN

COLOR RANGE





PS WALL PANEL CHARCOAL LOUVERS

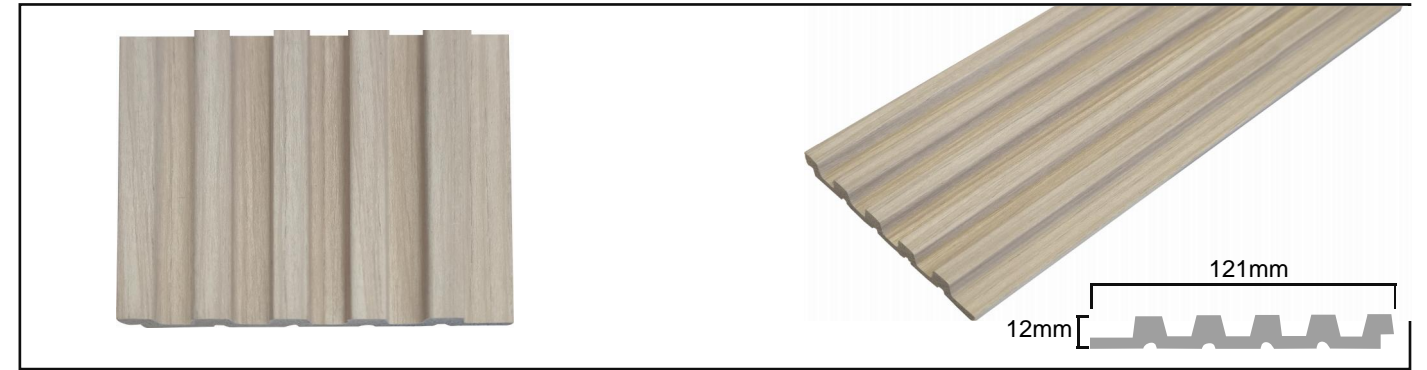

NAME	SIZE	CODE	AREA
PS WALL PANEL	2900*120.8*11.65mm	PS-5L	20 PCS/CTN

COLOR RANGE



PS-5L-101

PS-5L-113

PS-5L-122

PS-5L-135

SOULwood



SOULwood



PS WALL PANEL CHARCOAL LOUVERS

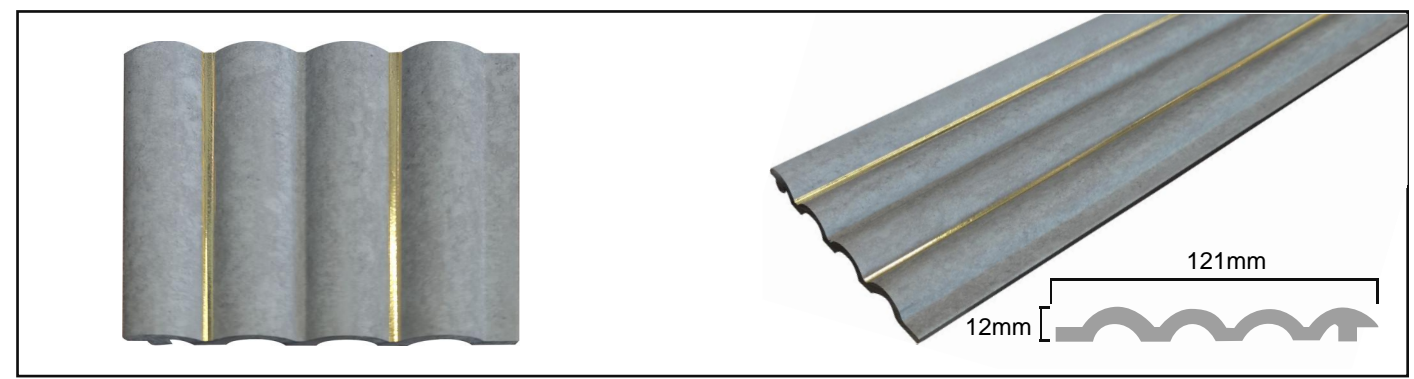

NAME	SIZE	CODE	AREA
PS WALL PANEL	2900*121*12mm	PS-4R	20 PCS/CTN

COLOR RANGE



PS-4R-144



PS-4R-150



PS-4R-169



PS-4R-176



PS WALL PANEL CHARCOAL LOUVERS

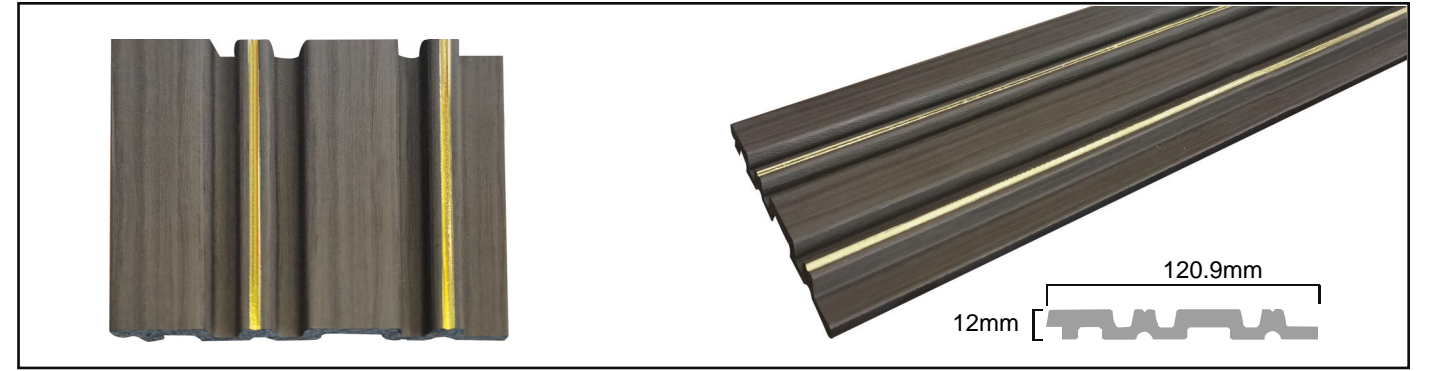

NAME	SIZE	CODE	AREA
PS WALL PANEL	2900*120.9*12mm	PS-BC	20 PCS/CTN

COLOR RANGE



PS-BC-203

PS-BC-215

PS-BC-239

PS-BC-241





PS WALL PANEL CHARCOAL LOUVERS

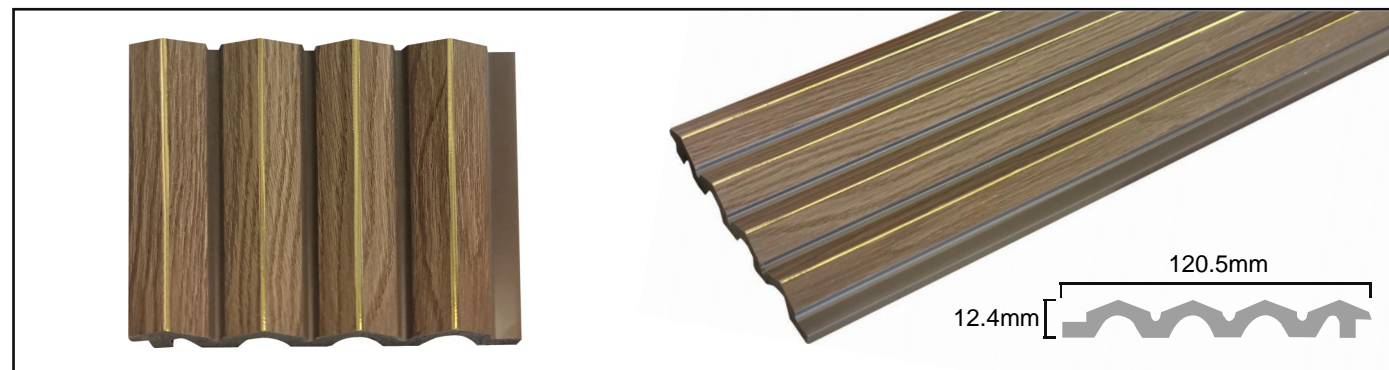

NAME	SIZE	CODE	AREA
PS WALL PANEL	2900*120.9*12mm	PS-4M	20 PCS/CTN

COLOR RANGE



PS-4M-266

PS-4M-273

PS-4M-284

PS-4M-295

SOUWood





PS WALL PANEL CHARCOAL LOUVERS

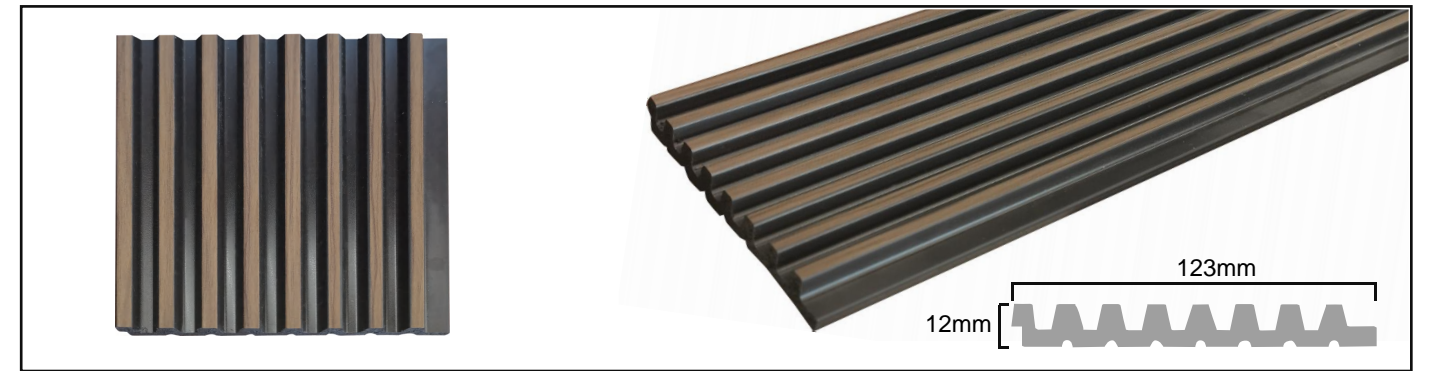

NAME	SIZE	CODE	AREA
PS WALL PANEL	2900*123*12mm	PS-8L	20 PCS/CTN

COLOR RANGE



PS-8L-409

PS-8L-418

PS-8L-487

PS-8L-499



**PS WALL PANEL**



NAME	SIZE	CODE	AREA
PS WALL PANEL	2900*122.5*10mm	PS-8C	20 PCS/CTN

**COLOR RANGE**

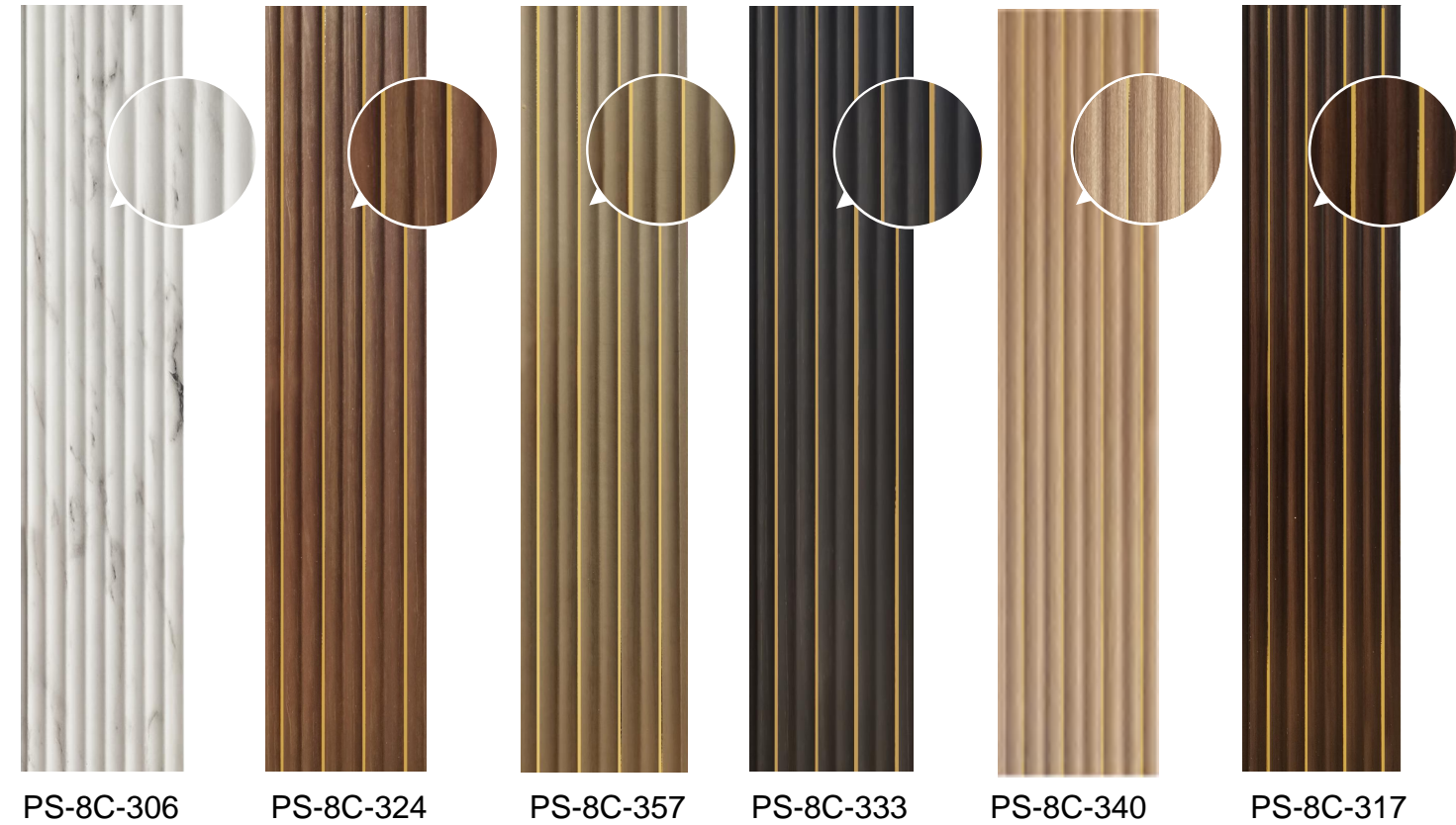

PS-8C-306

PS-8C-324

PS-8C-357

PS-8C-333

PS-8C-340

PS-8C-317



PS WALL PANEL CHARCOAL LOUVERS



NAME	SIZE	CODE	AREA
PS WALL PANEL	2900*125.5*8mm	PS-SB	20 PCS/CTN

COLOR RANGE

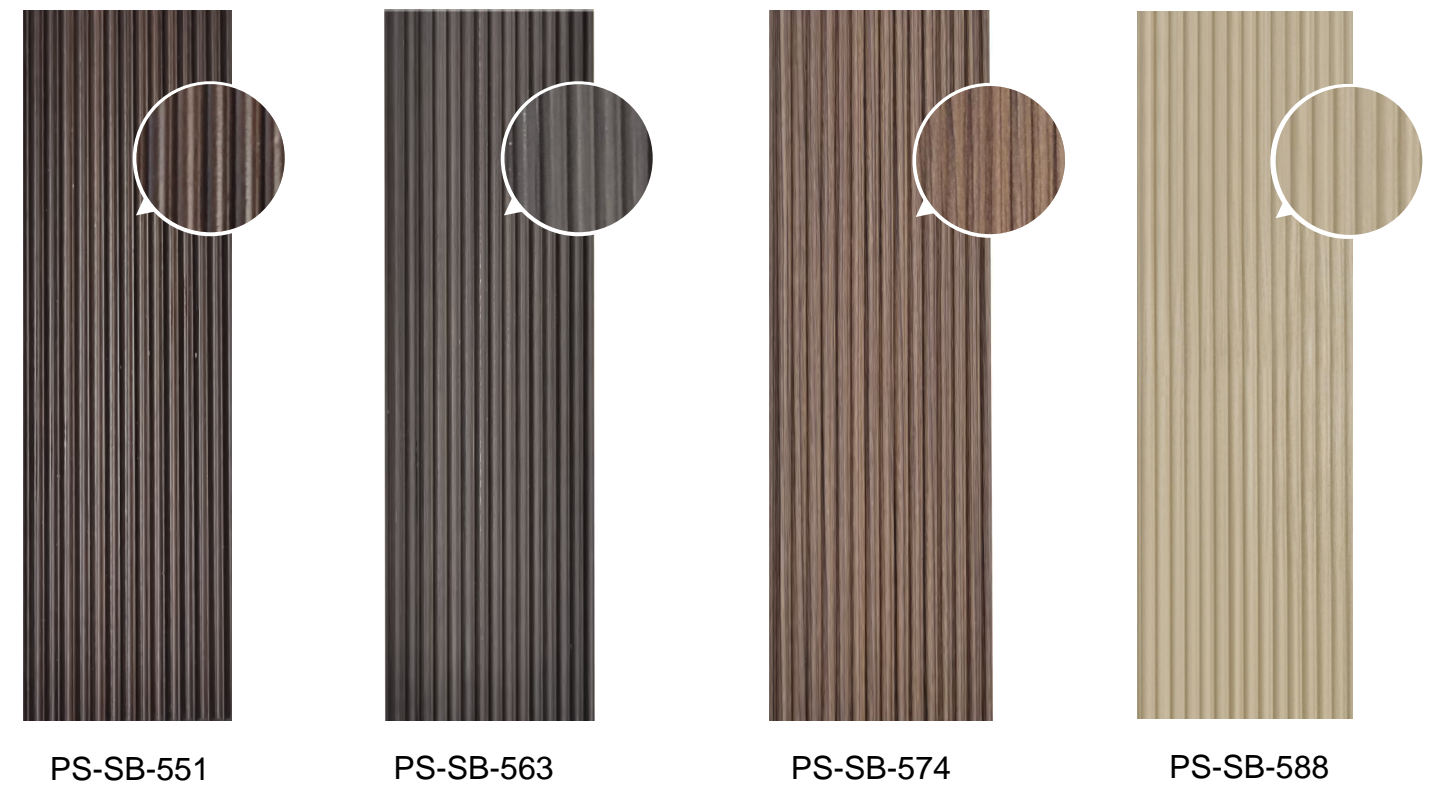

SOULwood®



SOULwood®



PS WALL PANEL CHARCOAL LOUVERS

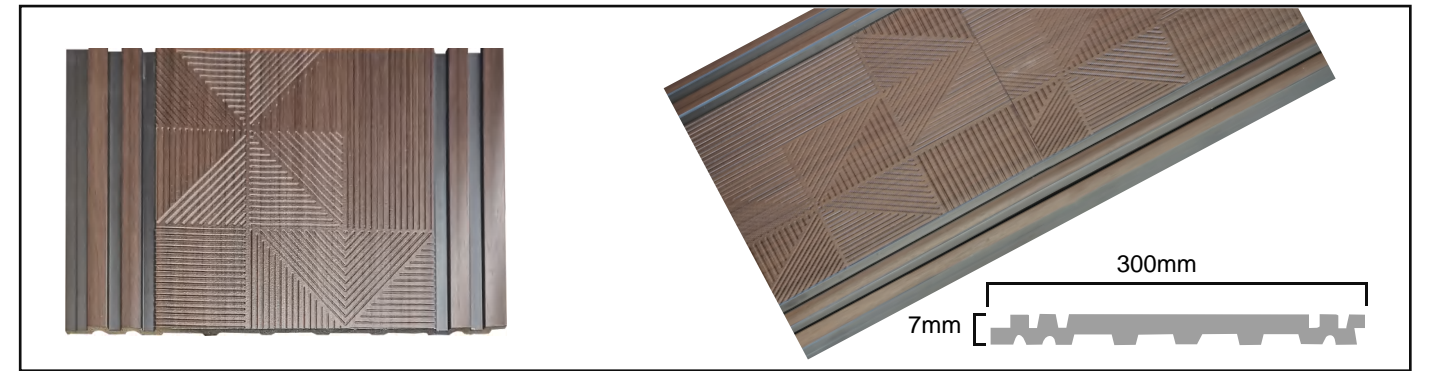

NAME	SIZE	CODE	AREA
PS WALL PANEL	2900*300*7mm	PS-303	10 PCS/CTN

COLOR RANGE



PS-303-79



PS-303-93

## ■ INSTALLATION

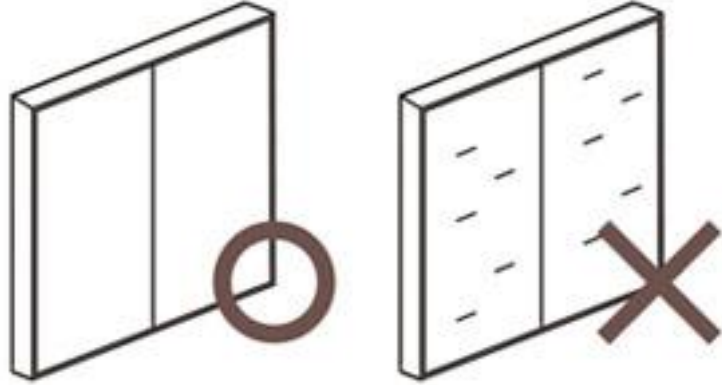

**1** Prep-work with plaster board or plywood is recommended before the construction. Please remove wallpapers on the walls before the construction.

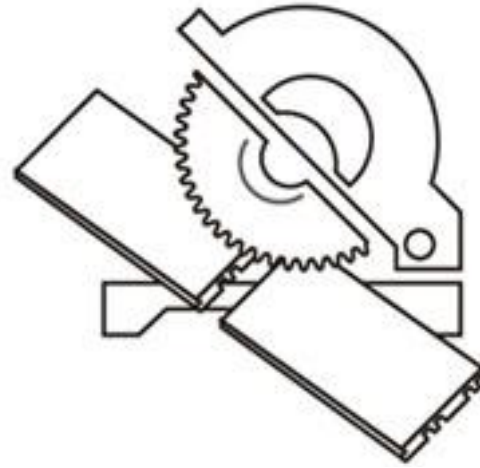

**2** Circular saw can be used for cutting.

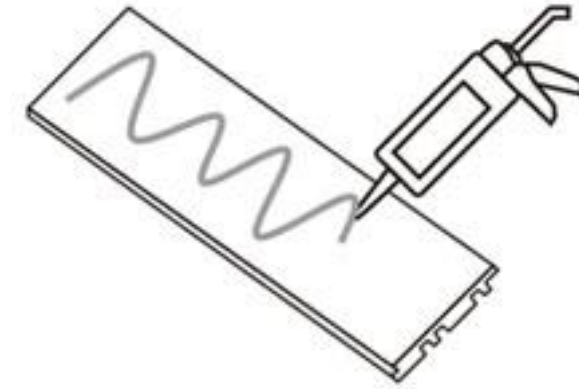

**3** Apply nail free glue on the back of wall panel.

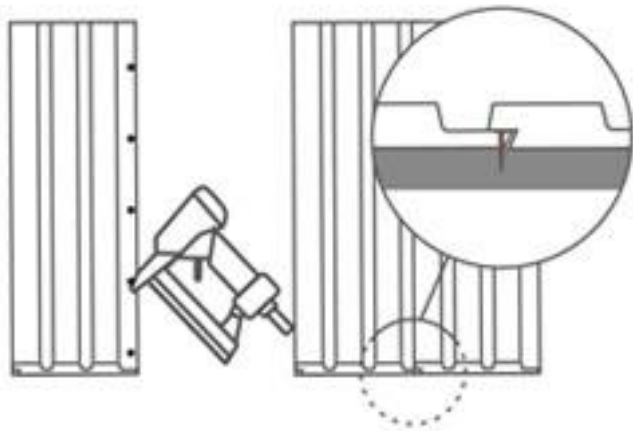

**4** Wall panel can be installed in both horizontal and vertical direction. Apply air-tacker on the edge of the tonue to hide the pin-marks.

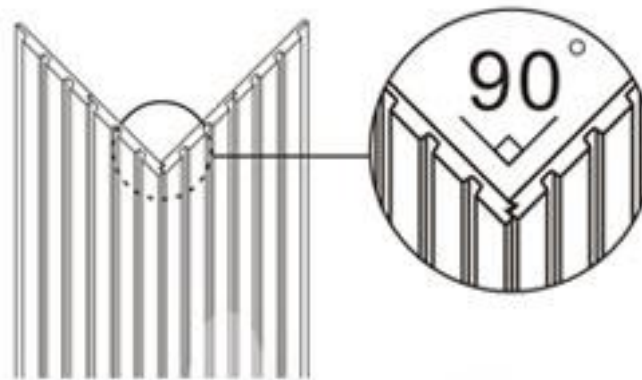

**5** For corner, combine the two grooves.



**6** Coordinating mouldings can be used for clean and nice finish.



# SOULwood®

